

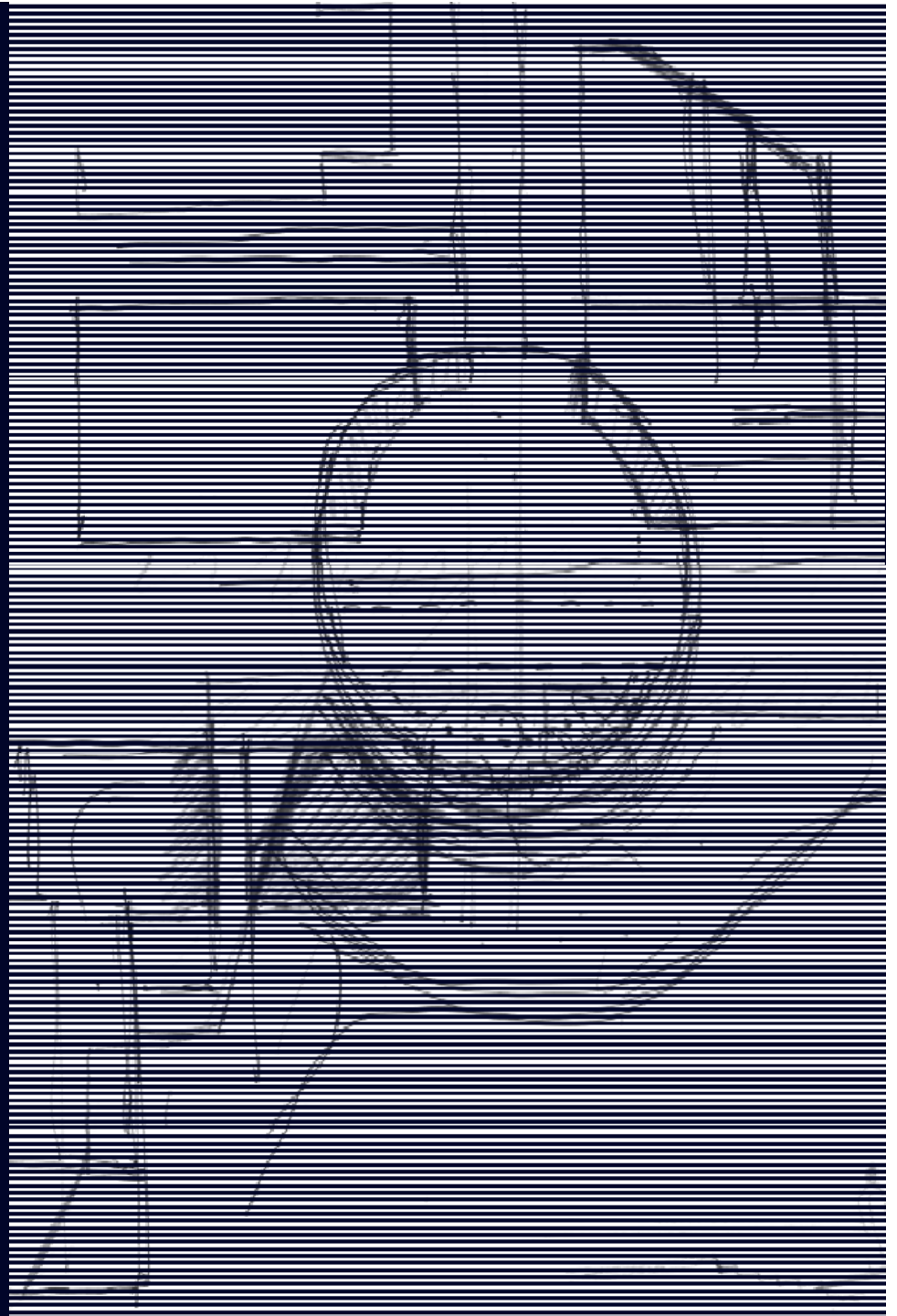

**MILWAUKIE SOUTH DOWNTOWN  
Steering Committee Meeting #3  
August 19, 2010**

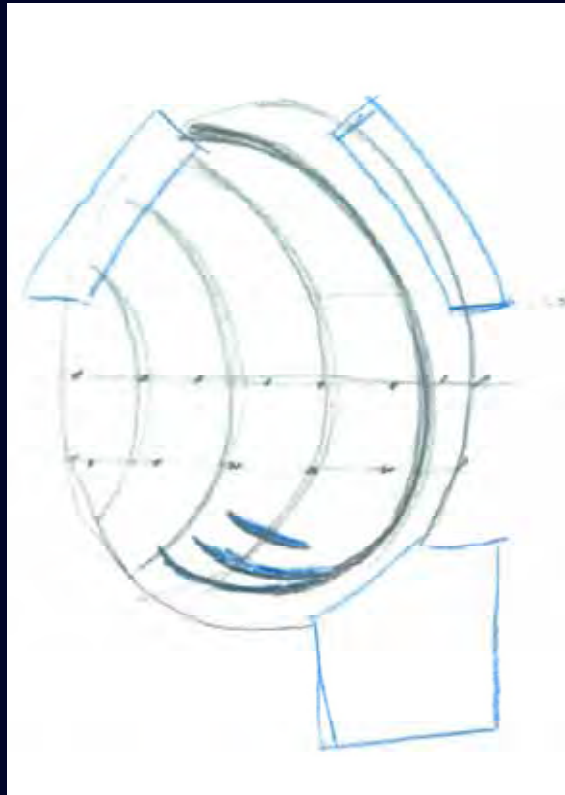

Plaza Sketches

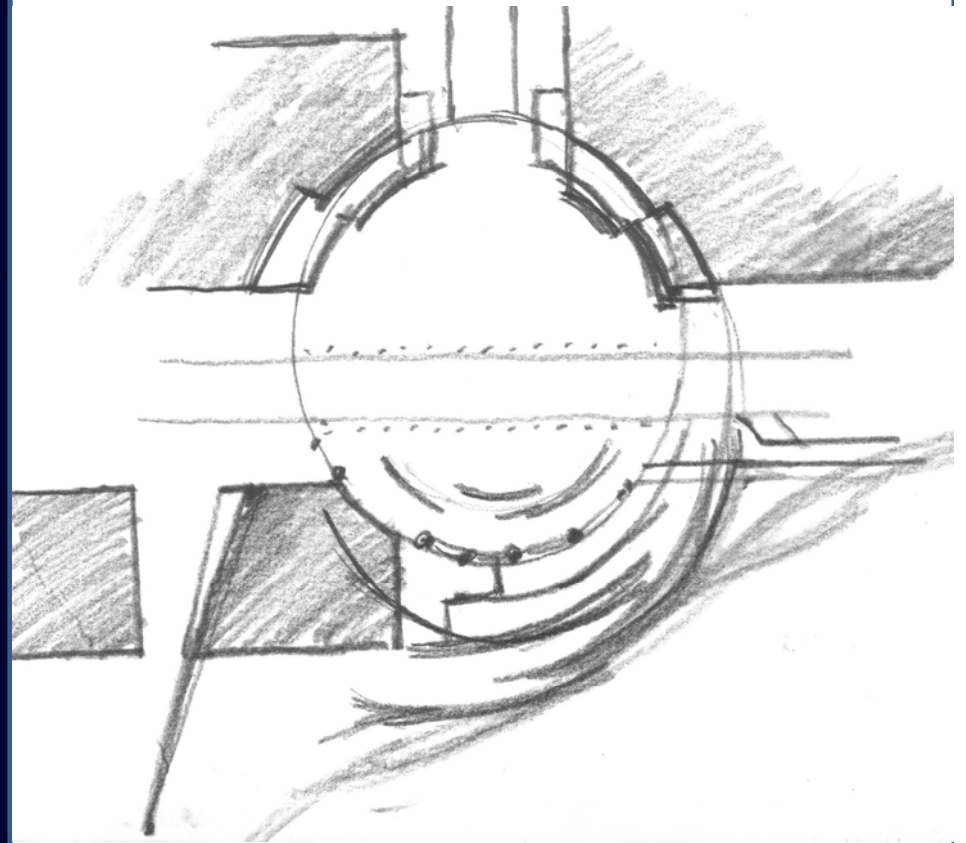
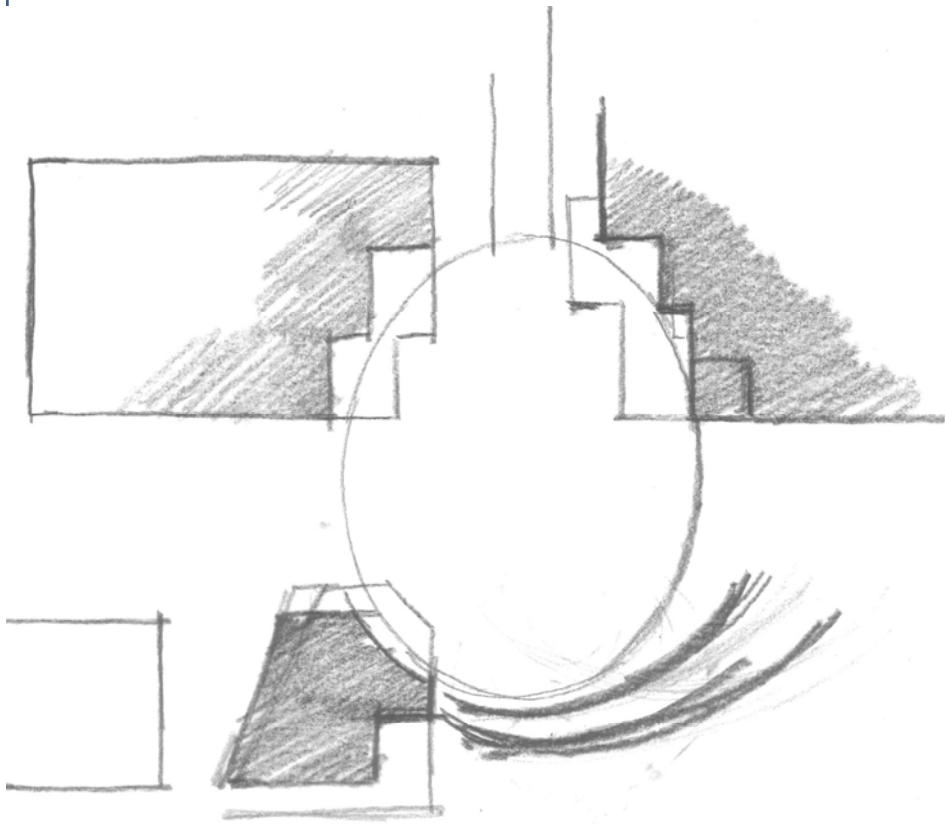

Plaza Sketches





Refined Scheme

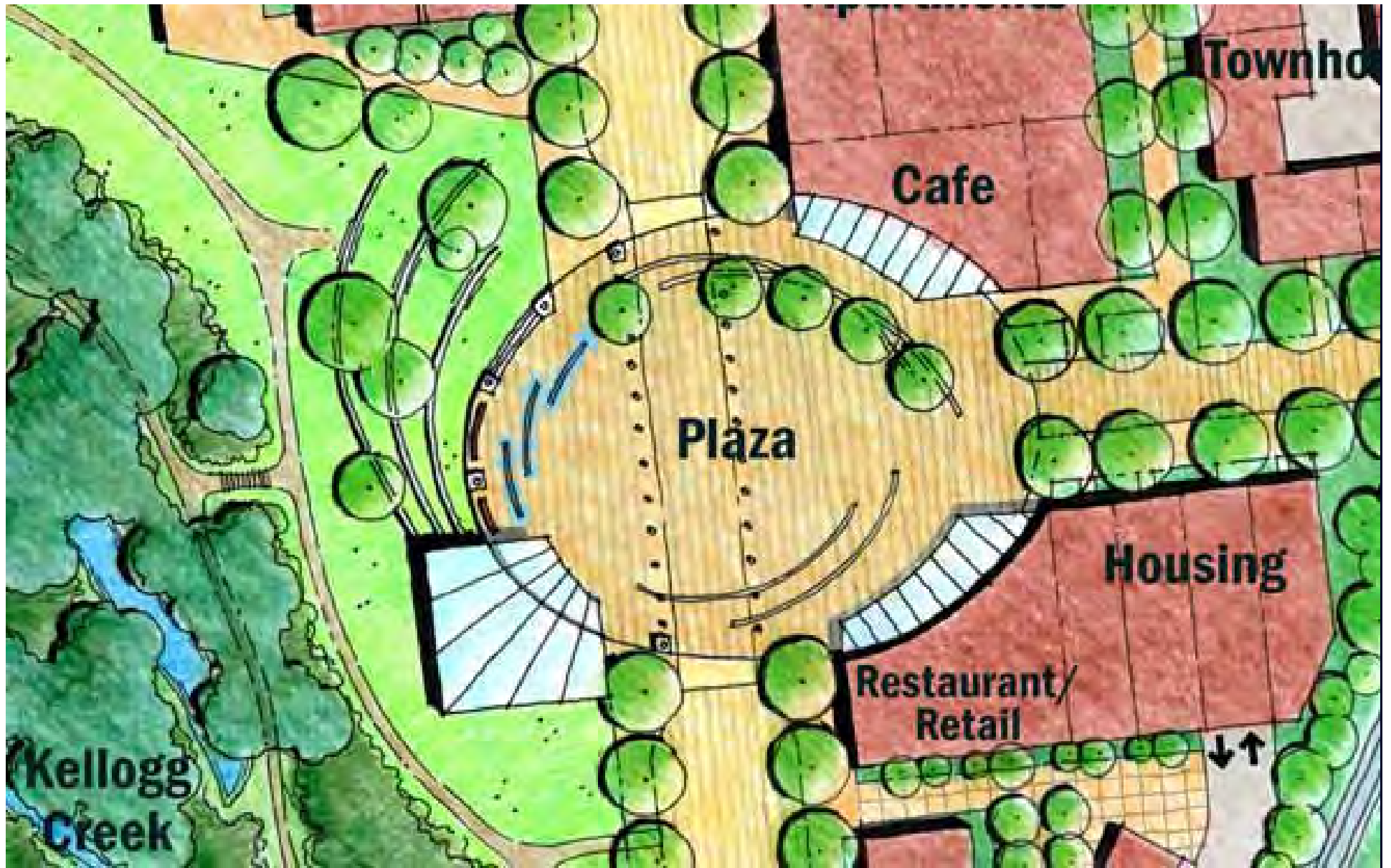

**Plaza Detail**

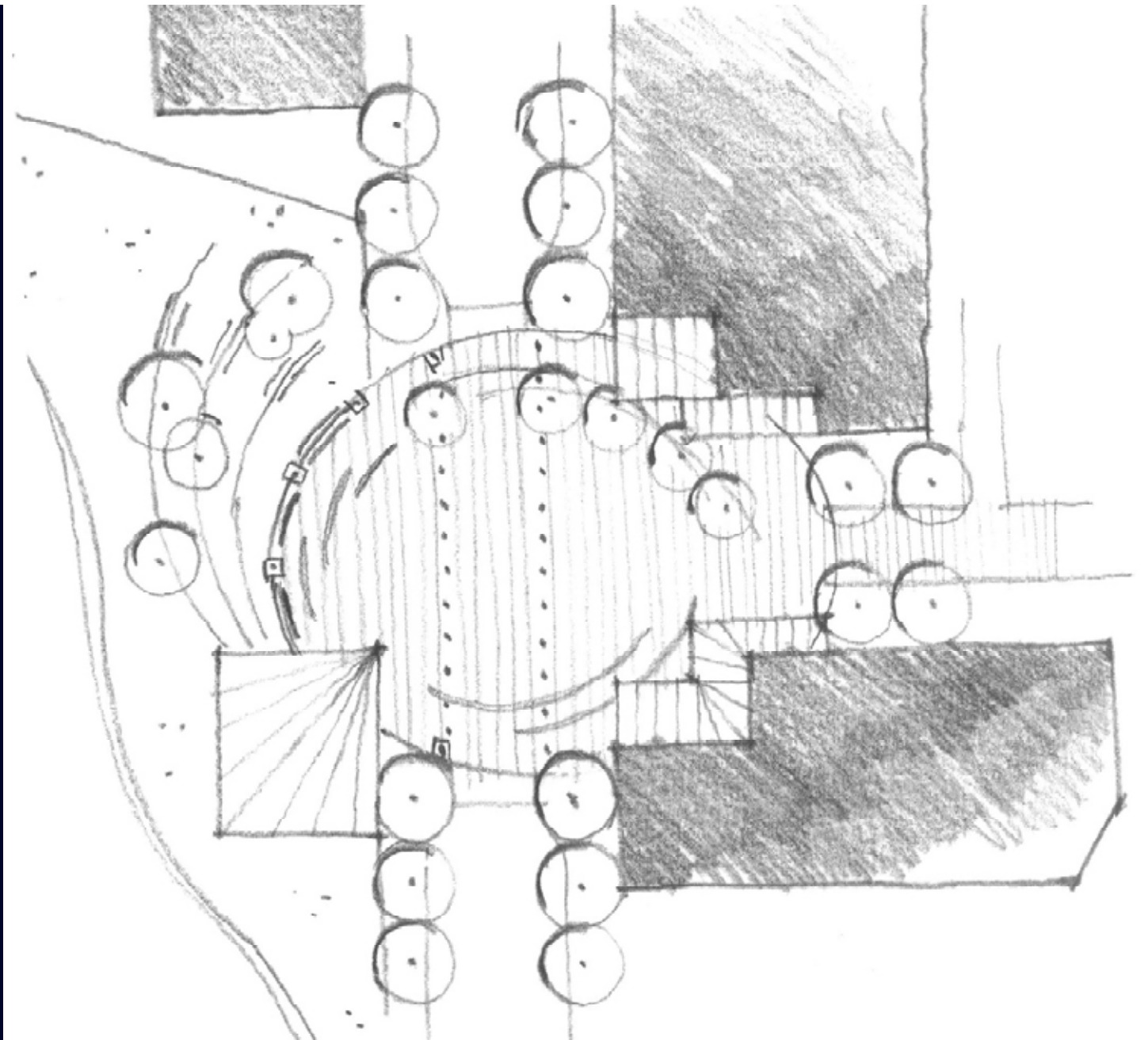

Plaza Edges







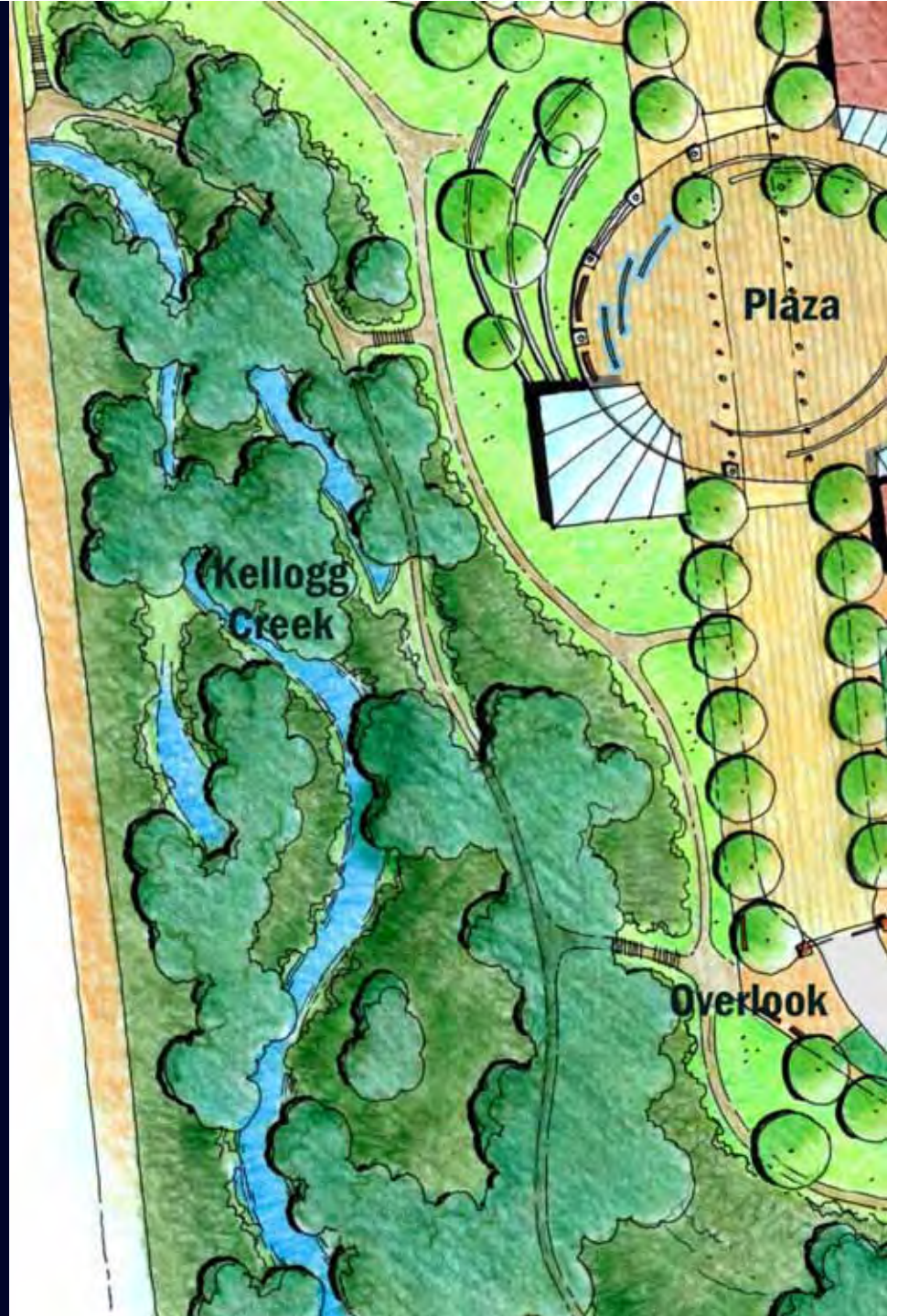











Refined  
Scheme:  
Market Layout





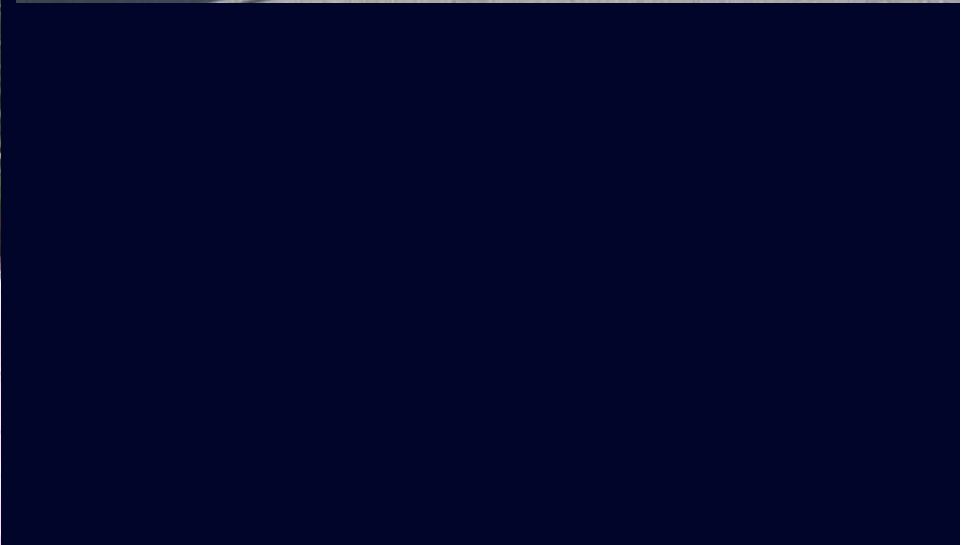



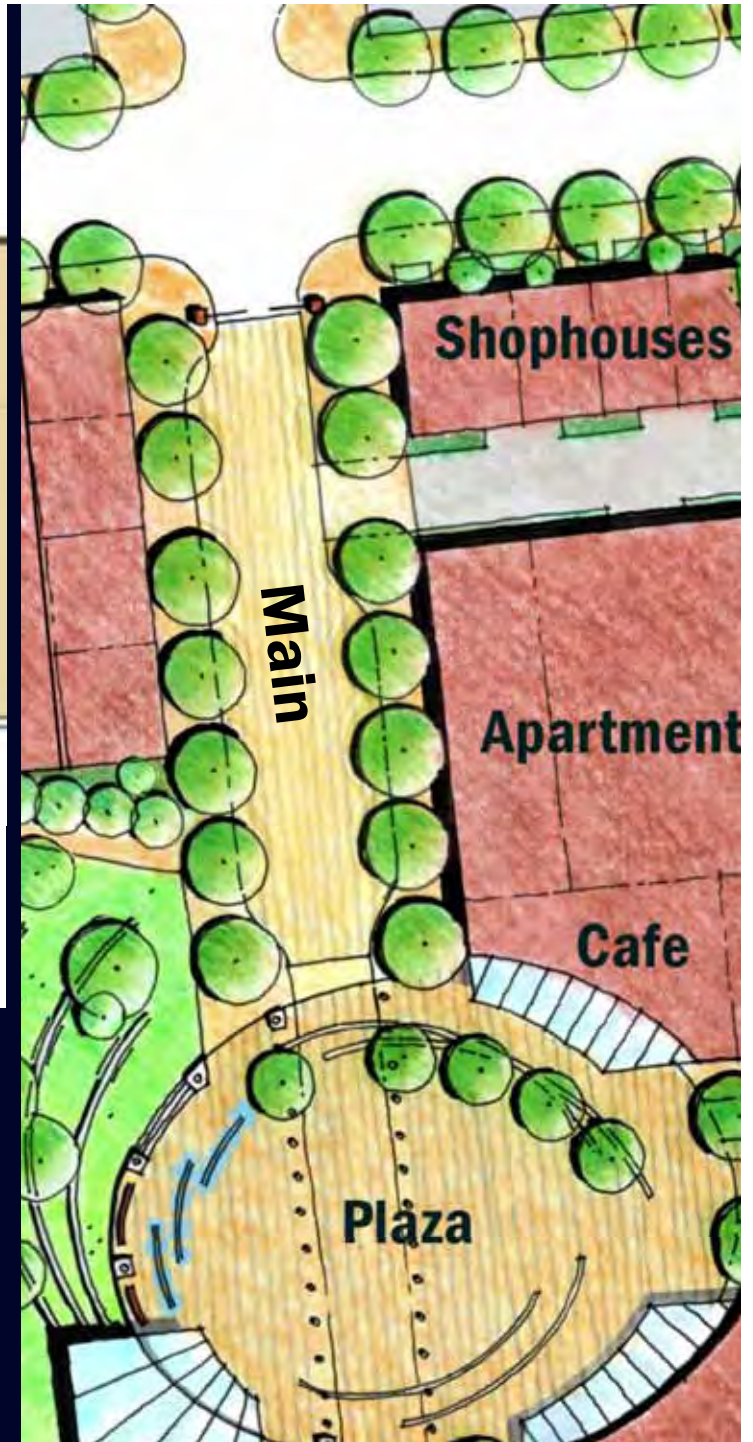
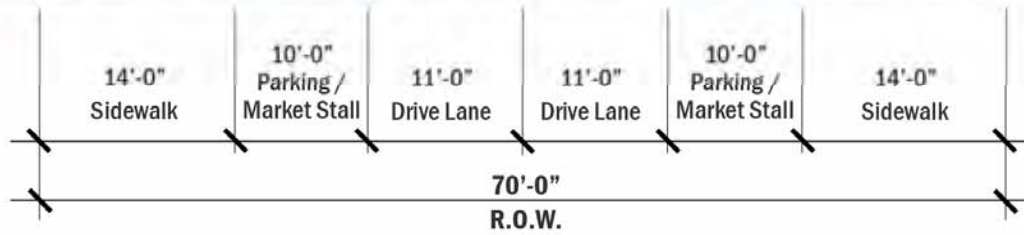



















Views





**View Corridor**





**Riverfront  
Park**

**Housing  
Over Parking/Retail**  
(35-45du)

Semi-Private  
Terrace

Retail

Retail



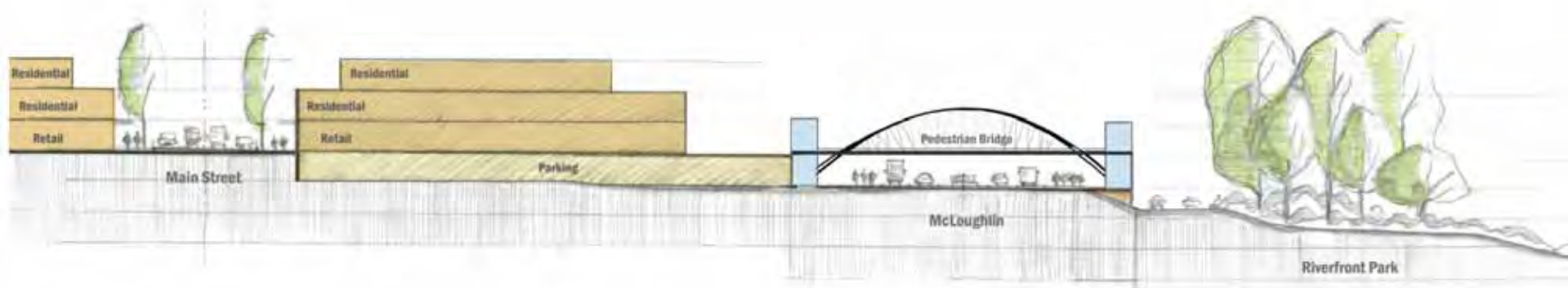

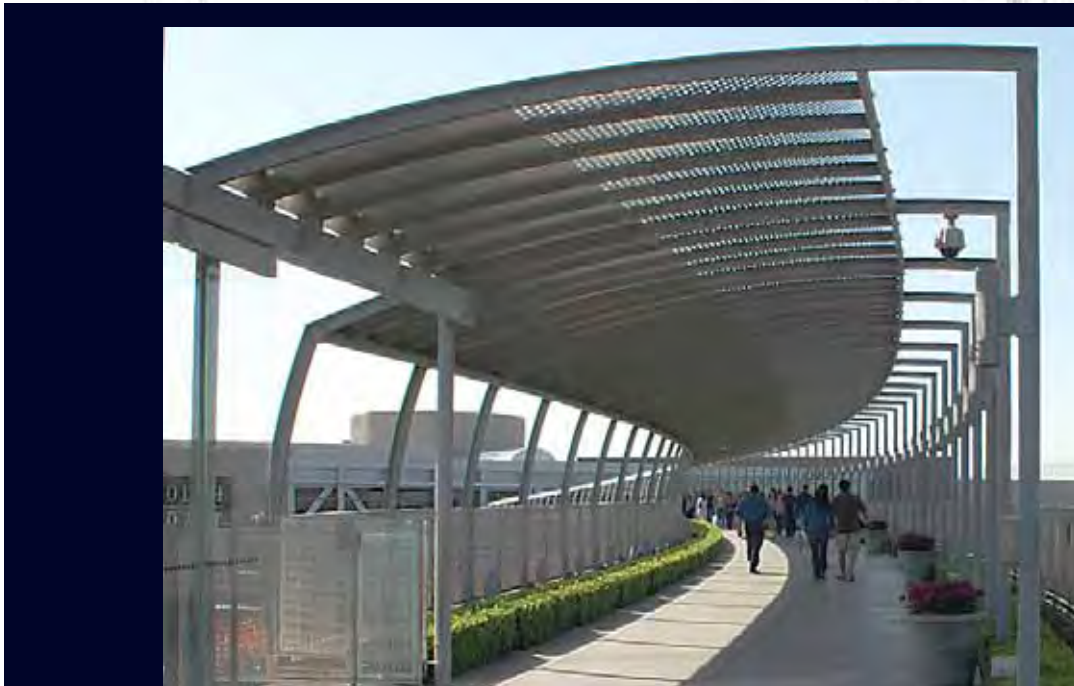
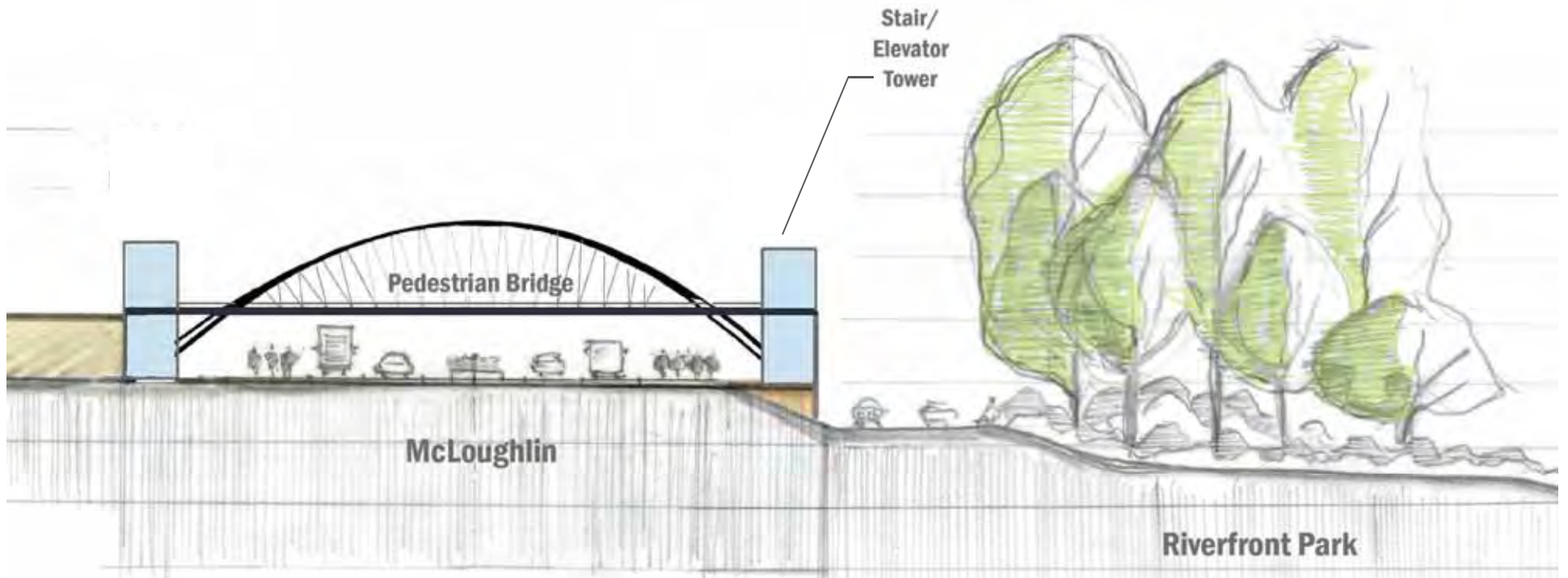







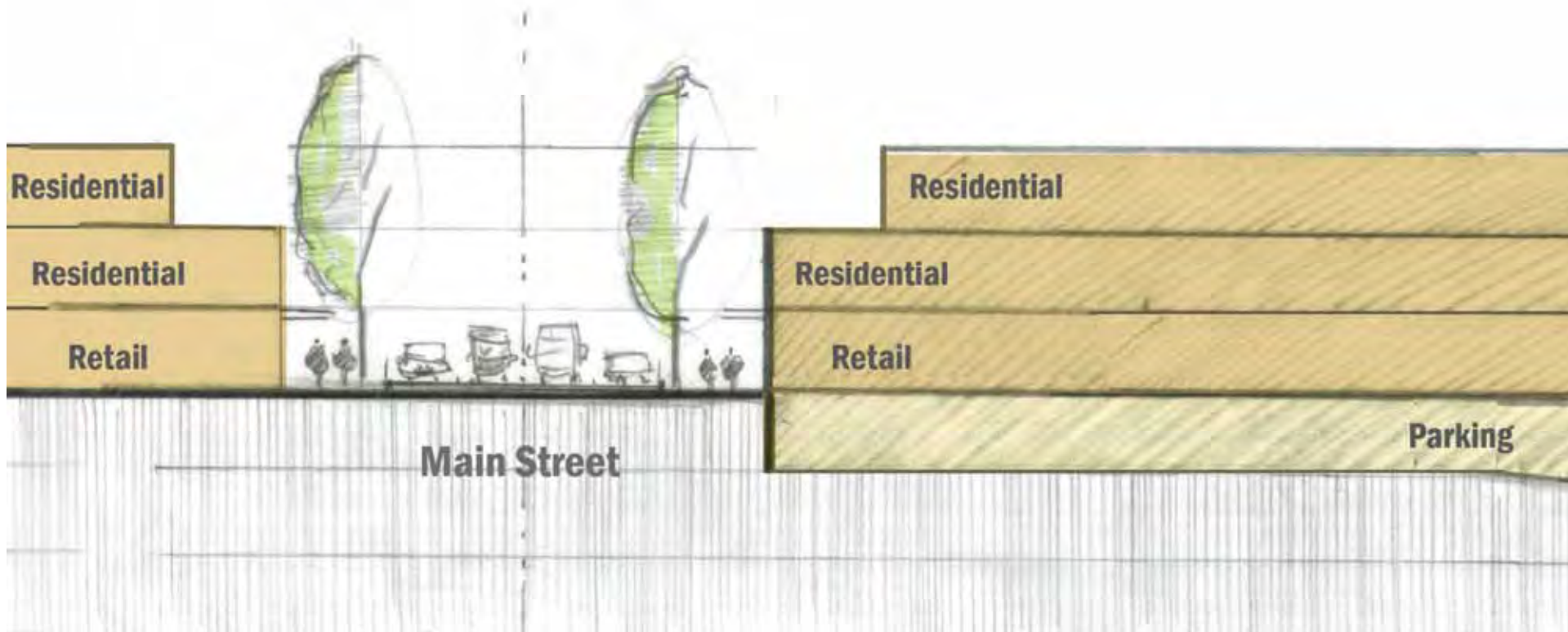





SE Washington St.

Total:  
(35-40du)

Shophouses  
(4du)

Shophouses  
(4du)

Retail

2-3 stories of  
Apartments

(15-20du)

Townhouses  
(10du)

Cafe

Plaza

SE Adams



























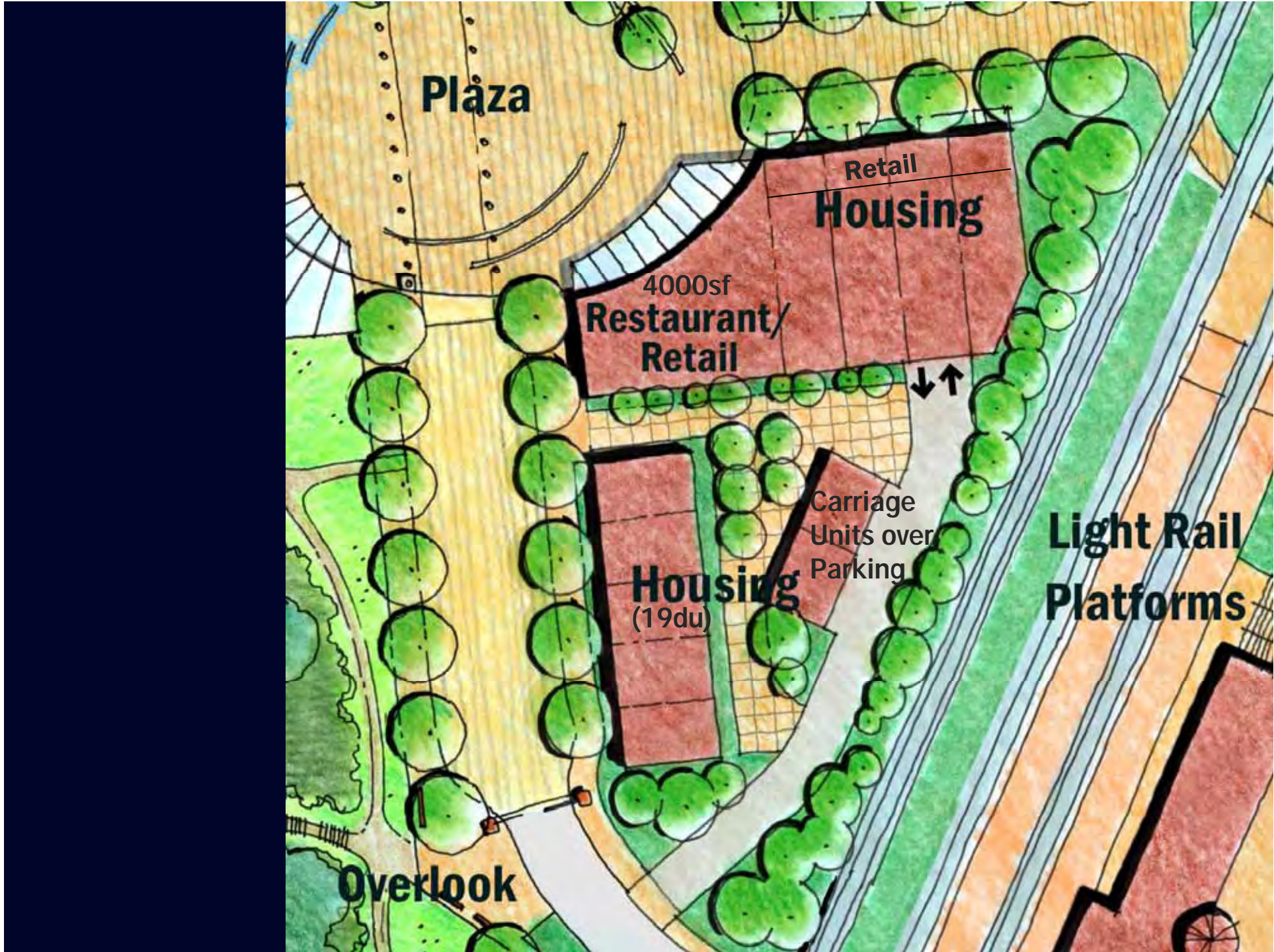







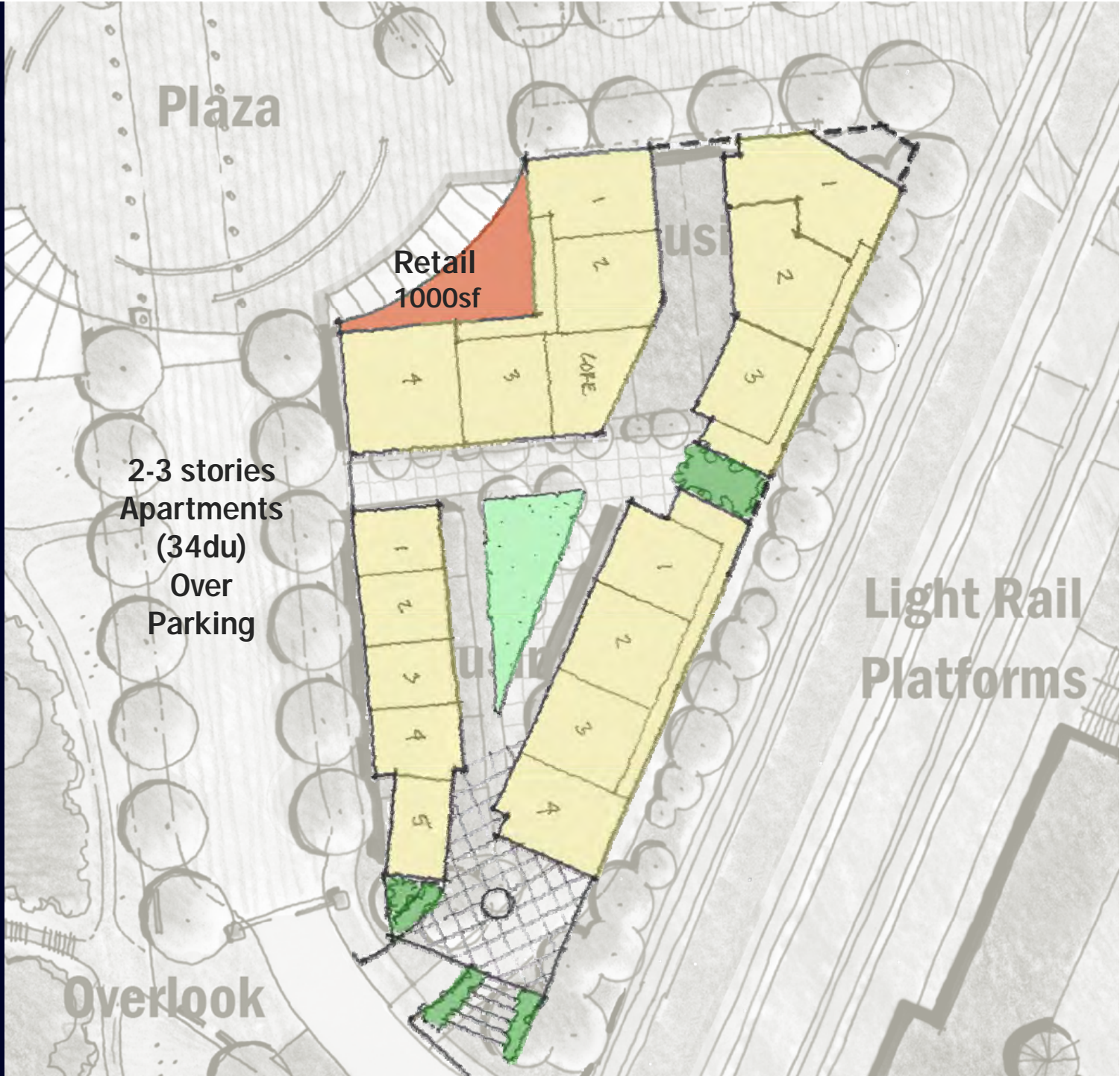

Plaza

Retail  
1000sf

2-3 stories  
Apartments  
(34du)  
Over  
Parking

Light Rail  
Platforms

Overlook



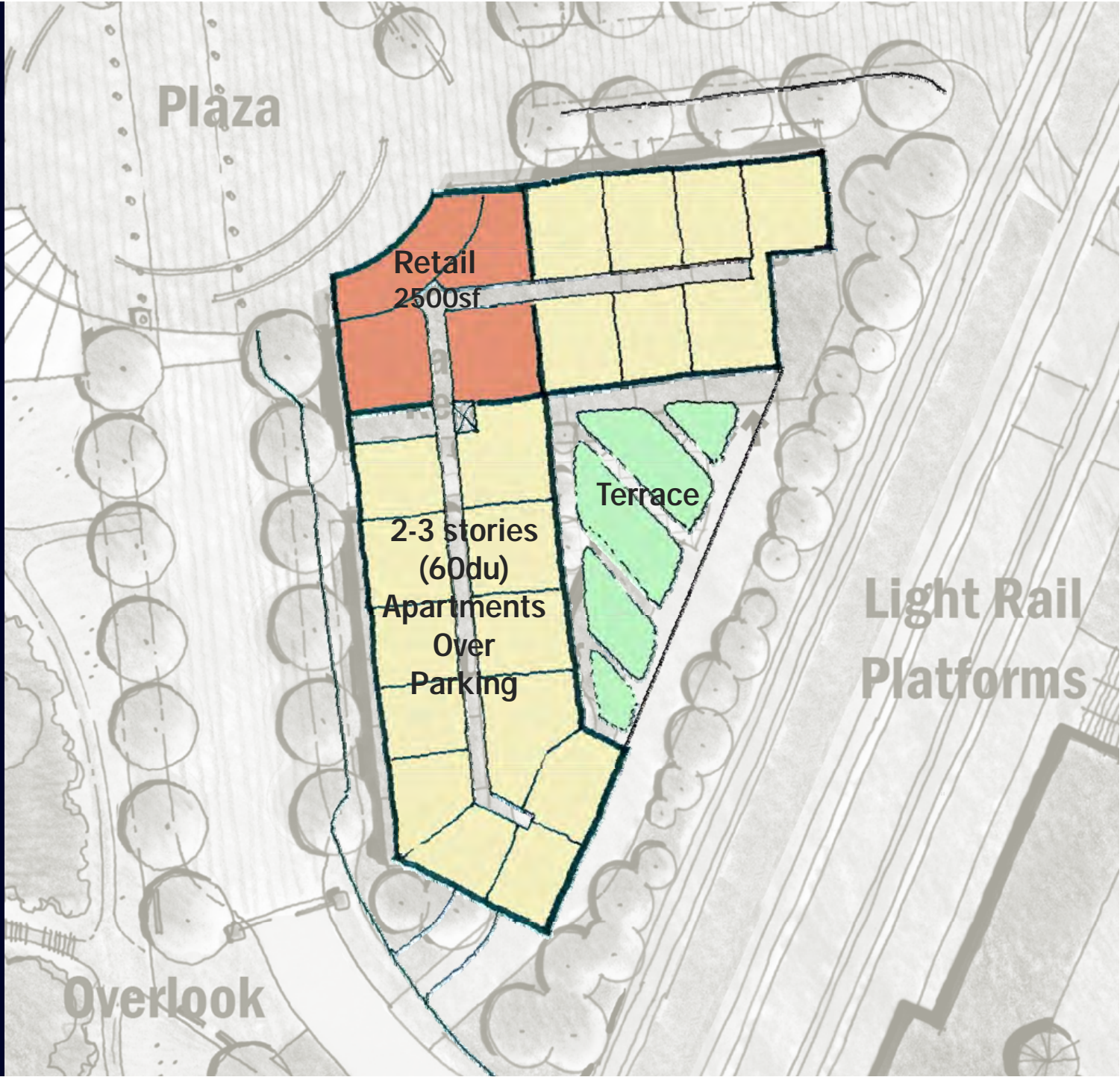



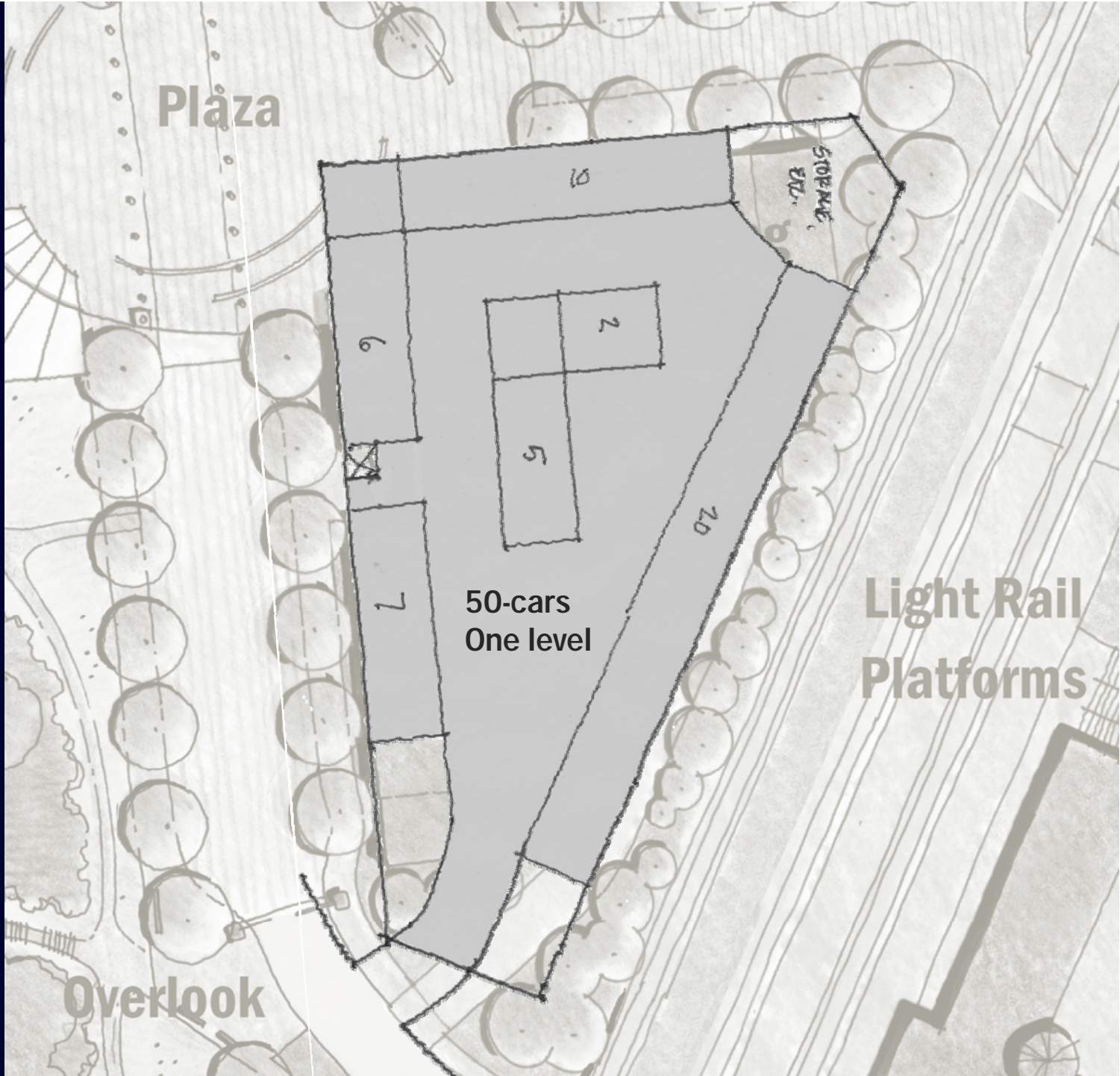



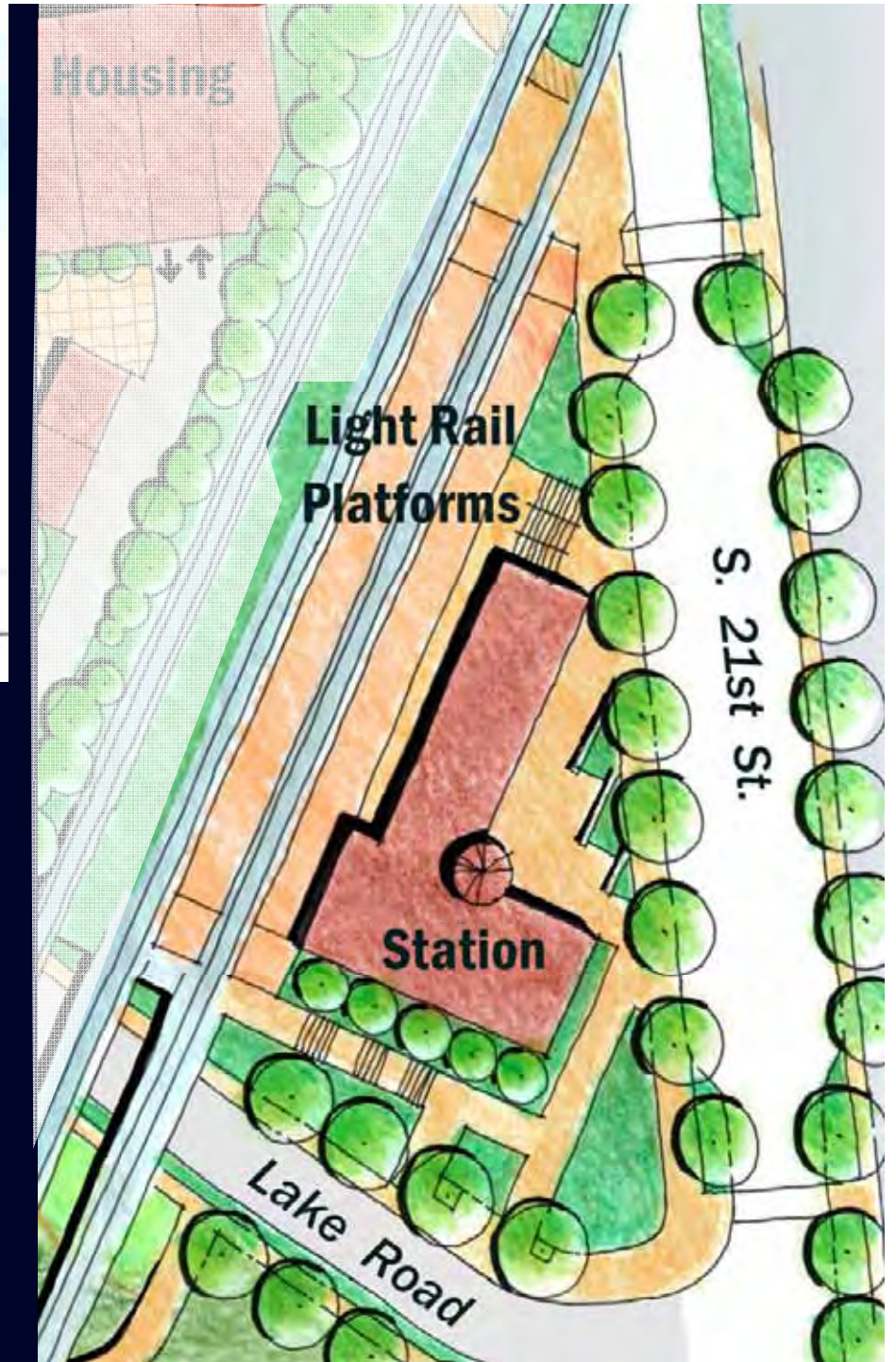



# *Small Group Discussion*

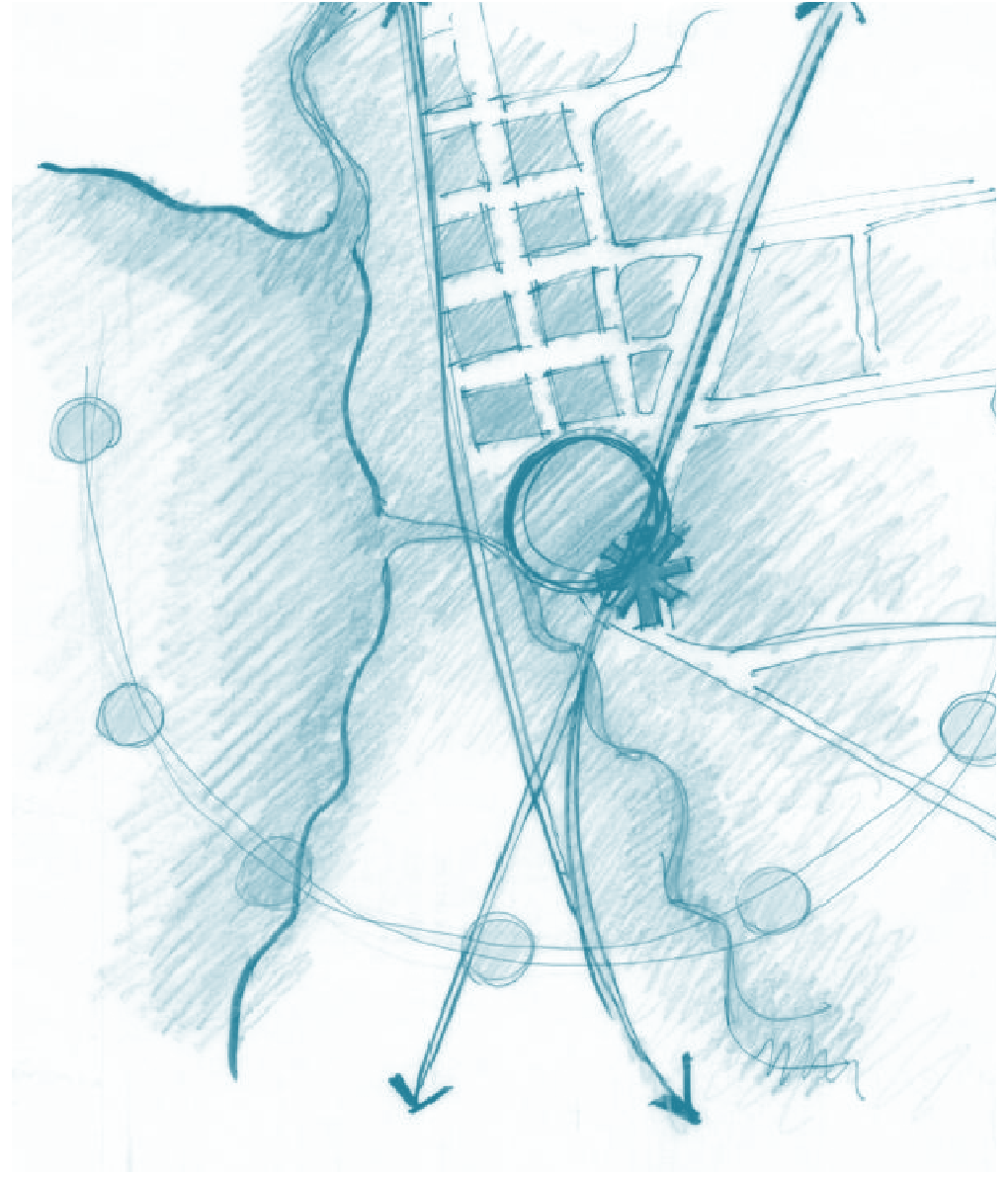



# Next Steps

[AsherK@ci.milwaukie.or.us](mailto:AsherK@ci.milwaukie.or.us)





**MILWAUKIE SOUTH DOWNTOWN**  
**Steering Committee Meeting #3**  
**August 19, 2010**